

Design Your Own Extension Dining Table

Classically proportioned tables with one 18" leaf and tops made from 5/4 and 4/4 thick solid Cherry or Maple.

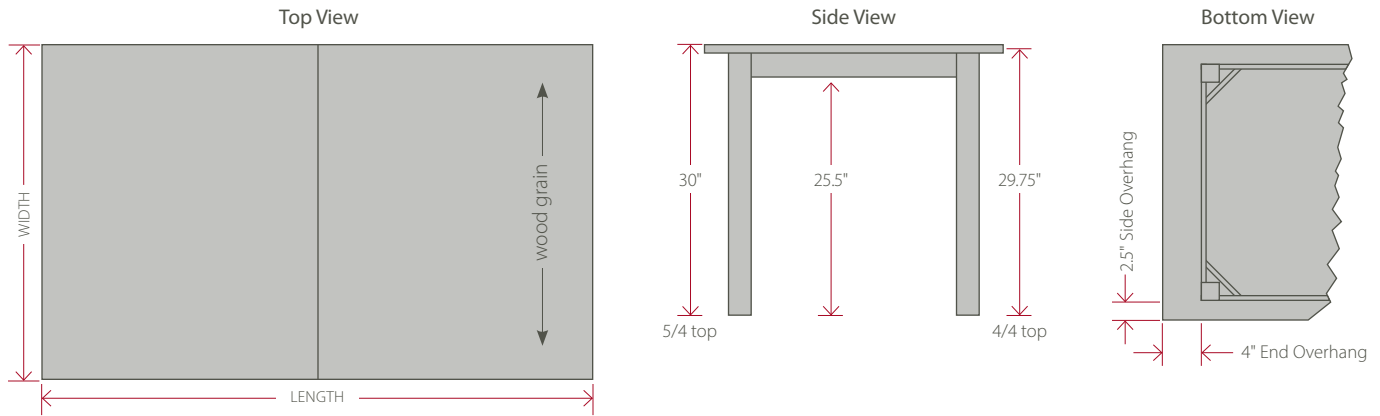

Tops from 4/4 thick lumber

		LENGTH				
		48"	54"	60"	66"	72"
WIDTH	36"	10350	10351	10352	10353	10354
	38"	10355	10356	10357	10358	10359
	40"	10360	10361	10362	10363	10364
	42"		10365	10366	10367	10368
	44"		10369	10370	10371	10372

Tops from 5/4 thick lumber

		LENGTH					
		66"	72"	78"	84"	90"	96"
WIDTH	40"	10150	10151	10152	10153	10154	10155
	42"	10156	10157	10158	10159	10160	10161
	44"	10162	10163	10164	10165	10166	10167
	46"	10168	10169	10170	10171	10172	10173
	48"	10174	10175	10176	10177	10178	10179

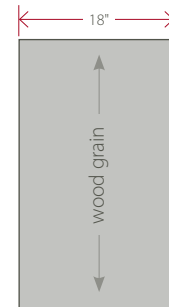

- One 18" leaf standard
- Additional 18" leaf available at an extra charge

Rectangular tables self-store one leaf only.

Top View

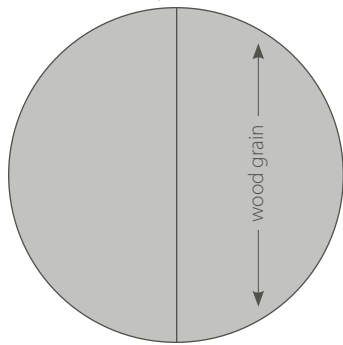

Bottom View

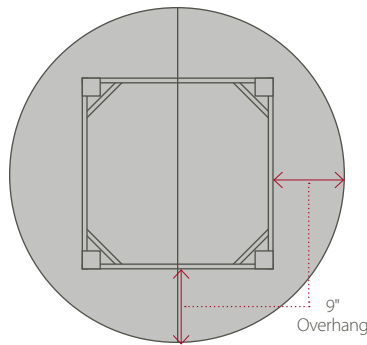

Tops from 4/4 thick lumber

DIAMETER	
42"	10347
45"	10348
48"	10349

Tops from 5/4 thick lumber

DIAMETER	
42"	10146
48"	10147
54"	10148
60"	10149

11.5" Overhang

Edges (side view)



Corners (top view)

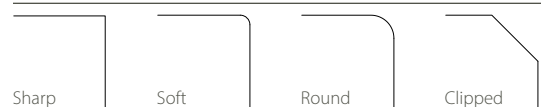

Small Legs

(2.25" x 2.25" x 29")

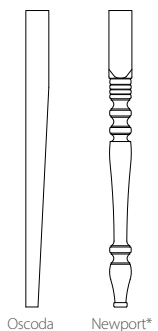

Medium Legs

(2.75" x 2.75" x 29")

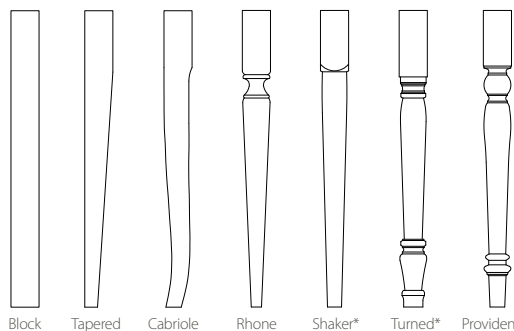

Large Legs

(3.5" x 3.5" x 29")

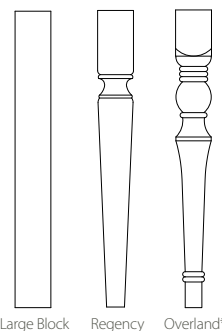

Counter Height Legs

(2.75" x 2.75" x 35") extra charge

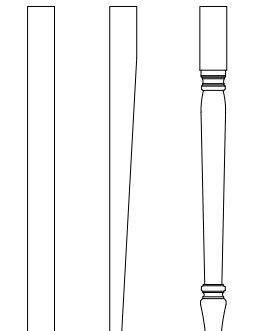

* These legs have a rounded or turned profile. Unmarked legs have a straight or tapered profile.